

# INSTALLATION MANUAL FOR BISOL SOLAR MODULES

**Before start of installation of BISOL solar modules, carefully read this installation manual in whole. This manual contains important information on safety, installation and other information like wiring, operating, maintenance and similar. If any further information is necessary, please consult your module dealer or manufacturer directly. Failure to follow these instructions may result in material damage and can in worst case jeopardise life safety and health. Store this manual in an easy reachable place.**

## FIRSTLY

We would like to thank you very much for purchasing BISOL solar modules.

BISOL solar modules are composed of high quality materials processed on state-of-the-art automated production line. BISOL PV modules are high energy efficient and designed for long-term high performance use.

## WARNINGS

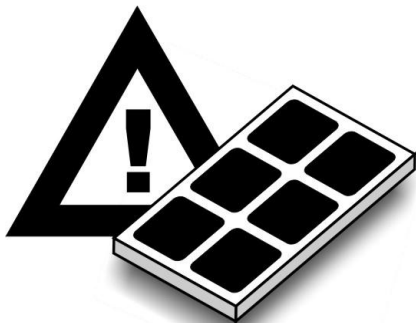

- Photovoltaic (PV) modules produce direct current when exposed to light, while even when disconnected high voltage present on module terminals,!
- Contact with active electrical parts can cause fire, sparks or even deadly electrical shock!
- Single module can produce only low voltage level, but when connected in series the voltage increases!
- Perform all the work with extreme caution and use only safe equipment (like appropriately isolated tools)!
- Do not mount and install the modules under inappropriate weather conditions like strong thrusts of wind, storms and similar!
- Installation tools and electrical connectors have to be dry! Do not connect PV modules with moistly connectors!
- Take care that electrical contacts are faultless (connectors have to be completely clean and fully inserted)!
- Do not open the junction box on the back side of the module!
- Never disconnect a module when it is under load! Remove the load first!
- Deadly electrical arc can appear when disconnecting connectors under load.
- Do not use modules that are damaged (e.g.: a module with broken glass)!
- Use only equipment, connectors, wiring and supporting constructions designed for use in photovoltaic systems!
- Be sure that module properties are suitable for conditions at the place of installation.
- Do not use the junction box for transportation help or for holding the module!

- Do not treat the back side of the module with paint, glue or sharp objects!
- Do not try to disassemble the module!
- Do not drop the module!
- Do not drop anything on the module!
- Do not step on the module!
- Do not bend the module!
- Do not wear metallic jewellery while you are performing installation of PV modules!
- Follow all safety measures for other components that are used in the system!

**When connecting large number of modules there is danger of deadly electrical shock!**

## **PACKING REMOVAL AND TEMPORARY STORAGE**

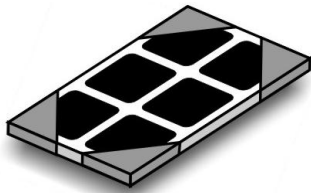

- Modules must be stored in dry and ventilated spaces (electrical contacts must be clean and dry)!
- Leave modules unpacked in their original packaging until you are ready to install them!
- When handling the modules take in account all the warnings!
- When transporting, storing and handling the modules take care not to damage the modules, yourself or other people!
- Carry the modules using both hands!
- Do not put weight on the modules and only stack modules in their original packaging.
- Do not remove any identification labels from the modules. It will result in void warranty.
- Write down and store the serial numbers of the modules.

## **MODULE INSTALLATION**

While installing the modules you must unconditionally follow general rules for safety at work, rules for electrical installation and devices,

construction rules and all other regional and national rules and regulations.

For roof mounting it is necessary to follow all the technical and working regulations in the roofing industry!

Acquire all the needed permits before starting the installation.

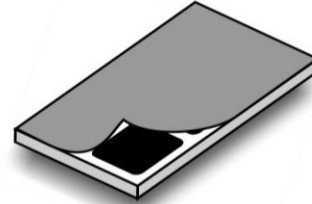

When installing the modules you have to consider following:

- Before installing cover the modules with an opaque cover to prevent the electricity being generated.
- Only appropriately qualified and trained personnel can perform the installation of PV devices and modules.
- When working on high places, appropriate safety measures must be taken!
- Only the area electrician with distributor's permission can connect the photovoltaic system to the public grid!
- Do not drill any holes into the frame or glass of the module. If you do, the warranty will be void.
- Do not expose the modules to concentrated light (use of lenses or similar)!
- Do not use different types of modules in the same system. When connecting the modules in series, use only modules that have the same current properties. When connecting the modules in parallel only use modules that have the same voltage properties.
- Connect together only the number of modules that is suitable for the connecting device (inverter, load balancer).
- Make sure that the module is suitable for use in the photovoltaic system.
- Maximum open circuit voltage of the system must never be higher than the maximum system voltage of the module.
- When connecting the cables and terminals make sure the polarity is correct.

- You should avoid any possibility of electrical shock when installing, wiring, operating and mounting the modules.
- The photovoltaic system must be electrically grounded.
- For wiring use only cables with cross-section and connectors suitable for the short-circuit current of the modules.
- Frames of the modules (or construction where the modules are fixed) should be grounded and protected from lightning strikes.
- Cables should be as short as possible to reduce voltage drop and maintain high system performance.
- When connecting several modules together, fix the wiring to the carrying structure.
- To prevent swinging of the wiring, use suitable fixing clips.
- In the areas where children or animals are present the wiring should be extra protected.
- Do not install the wiring over sharp edges!
- Make sure the carrying structure can handle extra wind and snow loads!
- Components used in the system must not have any harmful electrical or mechanical effect on the modules!
- Modules must not be mounted as a roof glazing!
- Modules must not be installed near waterfalls!
- Attention must be paid to all local, regional, national and international directives and appropriate standards!

## SUITABLE LOCATION

In order to get the highest energy yield the best suitable location for placing the modules should be found. In the northern hemisphere tilt the modules in direction of south and in the southern hemisphere to the north. For the optimal tilt angle of the module consult your local supplier of the photovoltaic equipment.

When mounting the modules, extra attention should be paid that the modules are not shadowed or even partially shadowed (e.g., by poles, chimneys, trees and similar), because shadowing affects negatively to the whole system. Even the smallest partial shadowing, like dust, decreases energy yield. A shadow free module is a module that is during the whole year newer shadowed and is able to receive sunlight between 9:00 and 15:00 even during the shortest day of the year.

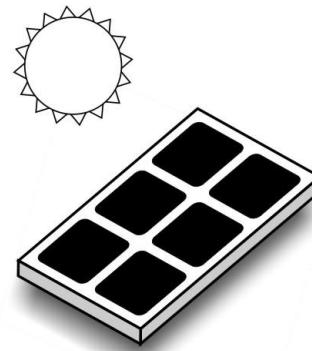

## SUITABLE ENVIRONMENTAL CONDITIONS

Modules are designed to be used in typical climatic condition and should not be installed in areas where danger of explosion exists. Modules may not be installed near areas with flammable gasses and steams (e.g., petrol station, gas reservoirs)! Modules may not be installed near open flames and flammable materials. Modules may also not be installed in toxic atmosphere (near sea, volcano, industry emitting toxic gases).

## MOUNTING THE MODULES

You can fix the modules on different structures. Supporting structure must be made of durable material that is not corrosive and is UV light resistant. Make sure that the supporting construction has enough power to hold different loads like snow, wind and similar, and is in accordance with local standards and regulations.

Examples of mounting the module on a supporting construction:

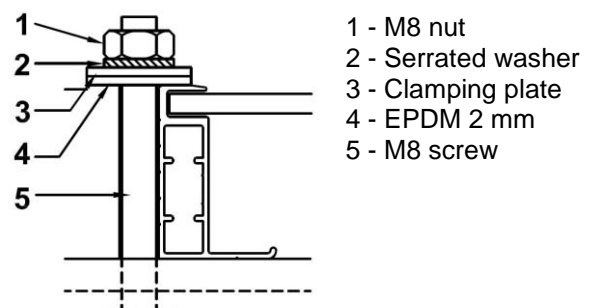

Example 1: Clamping on

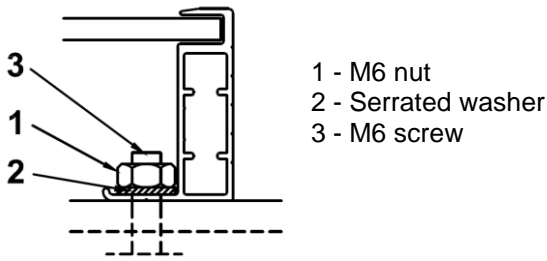

Example 2: Screwing on

Modules have to be reliably mounted at least on four places. Frame is statically designed to be fixed on the long frame side (holes on the long frame side are already drilled so you do not have to drill them by yourself). Fixing on the short frame side is not allowed. Use only existing holes. Any further drilling is forbidden and subject to Warranty loss! Use only suitable stainless mounting materials! We recommend use of torque wrench for tightening.

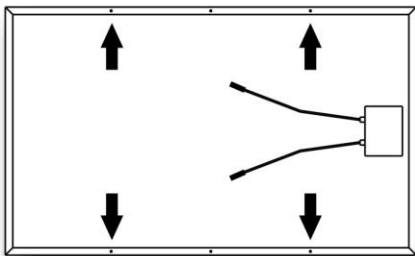

The holes for mounting the module ( $\varnothing 7.0$  mm)

The back sides of the modules must be well ventilated. Effective ventilation prevents power drop due to higher module temperature and improves drying of the modules.

When mounting the modules, take into account thermal expansion of modules. It is recommended to leave at least 5 mm space between neighbouring modules.

## WIRING

PV modules produce direct current when exposed to light, while voltage is always present on the module.

Single module can produce only low level voltage. When several modules are connected in series, the voltage increases. Summation of voltage takes affect.

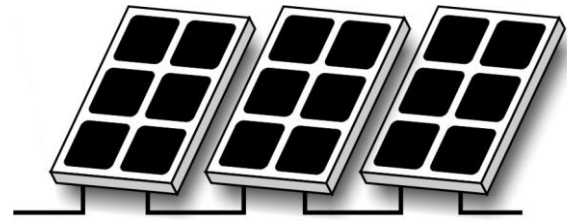

Serial connection

When modules are connected together in parallel, summation of current takes affect.

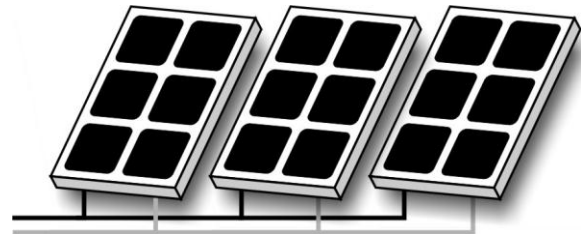

Parallel connection

When parallel and serial connection combines, summation of current and voltage takes affects.

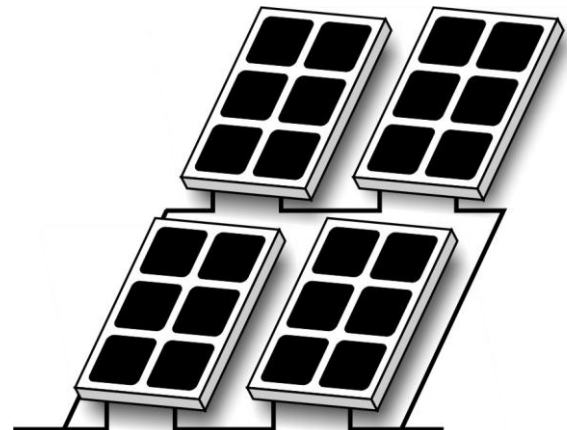

Combined (parallel and serial) connection

When wiring the modules, consider the following:

- Modules are designed for application up to 1000 V DV only (Application Class A).
- Do not connect more than 21 modules in series in order to respect the maximum voltage limit.
- When over-current protection is applicable, the protection must not exceed 13 A (use of DC fuses for up to 1000 V is recommended).
- In case of parallel connection, respect the over-current protection instructions discussed in this manual.
- Use only suitable cable extensions and connectors suitable for outdoor use.

- Make sure the electrical cables and connectors are electrically and mechanically fault free.
- Do not loop electrical connections (decrease the risk of indirect lightning strike).
- Use only wiring with suitable conductor cross-section (multiply  $I_{SC}$  and  $U_{OC}$  values with factor of 1.25 when calculating the smallest cross-section needed).
- Make sure the connectors are fully connected.
- Protect freely lying connectors with suitable measures (e.g., protective enclosure).
- Fix the cables only with UV resistant materials.
- Before connecting the system, verify the correctness of connections. If the measured values of open circuit voltage and short circuit current are deviating from expected values, you probably have a bad (wrong) connection.

The electrical specifications are on the label of the module. The label can be found on the back side of the module.

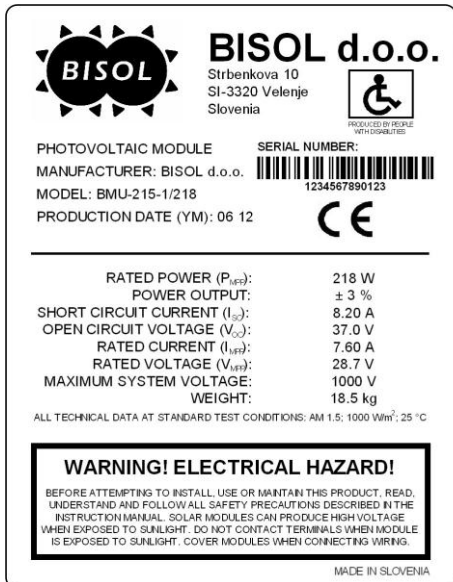

An example of the label

## GROUNDING

Frames of the modules (or construction which the modules are fixed to) should be grounded and protected against lightning strikes.

Only trained personnel may implement the grounding of the frames of the modules.

Grounding can be done by attaching the grounding wire to the module frame. Two holes are already present on the frame for this purpose (diameter of 4.5 mm). Use serrated screws (diameter of 5 mm) or a stainless steel serrated washers to assure good conduction. Grounding can also be done by mutually connecting the modules with electrically conducting supporting structure. Serrated washers should be used for mounting, to assure good electrical conductivity. Grounding can then be done by grounding the supporting structure.

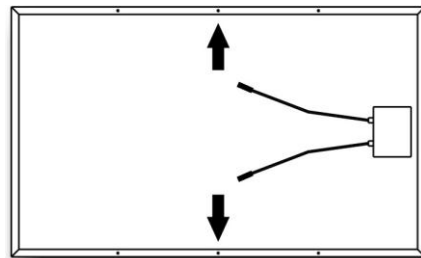

The position of holes for grounding the module (Ø4.5 mm)

## MAINTENANCE AND CLEANING

Regularly check the modules:

- Visual check: firm mounting, cleanliness, absence of corrosion and intact mounting and electrical connections.
- Carry out test of grounding resistance.
- Periodically measure output current and voltage.
- Control the change of surroundings (e.g., new sources of flammable gases, sources of shadows ...).

Do not use chemical detergents when cleaning the modules! In case of heavier pollution (it causes reduction of power yield), we recommend cleaning the modules with plenty of water. Mild detergents can be used with it. If it is necessary, soft sponge or soft rag can be used. Do not rub modules. Rubbing the modules can cause scratches. Tilt angle of the modules is usually greater than 15°, which means generally no module cleaning is needed. The modules are usually sufficiently cleaned by meteor water. In

cases where tilt angle of the modules is smaller than 15°, more frequent cleaning of the modules is necessary.



## DISCLAIMER OF LIABILITY

In case of any kind of intervention into the module integrity, BISOL's warranty of its products is being deemed void. In order for warranty to be valid, all warranty pending modules have to be free of defects caused by the user, while the use of the modules itself has to be performed according to measures of this document and corresponding sub-documents.

BISOL, d.o.o. accepts no liabilities, if instructions in this manual are not followed. Since understanding of these instructions, conditions, installing methods, connections, use and maintenance of modules is not controlled or inspected by BISOL, BISOL accepts no responsibilities for damage that could arise from failure to implement predicted preventive measures, installation deficits, incorrect connection, usage or maintenance.

Liability for infringements of patent law or of other third party rights arising from the use of the modules is excluded.

**By using this installation manual it is necessary to reasonably use all technical parameters of the products stated on the products itself, as well as all other technical parameters of complete technical documentation.**

### **BISOL Proizvodnja, d.o.o.**

Latkova vas 59a  
SI-3321 Prebold  
Slovenia

Phone: +386 3 703 22 50  
Fax: +386 3 703 22 63

E-mail: [info@bisol.si](mailto:info@bisol.si)  
Web: [www.bisol.si](http://www.bisol.si)

March 2011  
Version: 2.2